

ALUMINIUM BLIND PERFECT FIT FITTING INSTRUCTIONS

FITTING COMPONENTS

Please check that you have all parts from the kit above. If any of the items are missing, please call 01924 481 717 or email info@blindsdirect.co.uk



Frame clips x4 minimum (heavier blinds may require more)

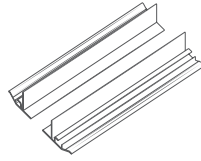

Side frame x2

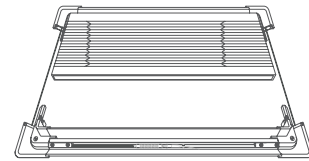

Top frame with blind & Bottom frame



Frame fixing screws

FITTING HARDWARE



Philips head screwdriver



Credit card

1 Frame and Tension Cord

The top and bottom of the frame, and internal blind are all connected by the tension cord. Lay flat and extend the cord to enable the corner joints and side frame bars to be fitted.

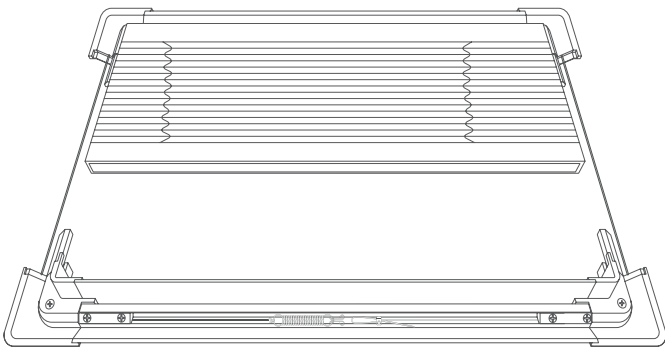

2 Corner Joints

Slot one of the side frames into the bottom frame, making sure to line up the five small holes at the corners, then screw it into position. Repeat for the other side frame. Ensure that the tension cord remains in place.

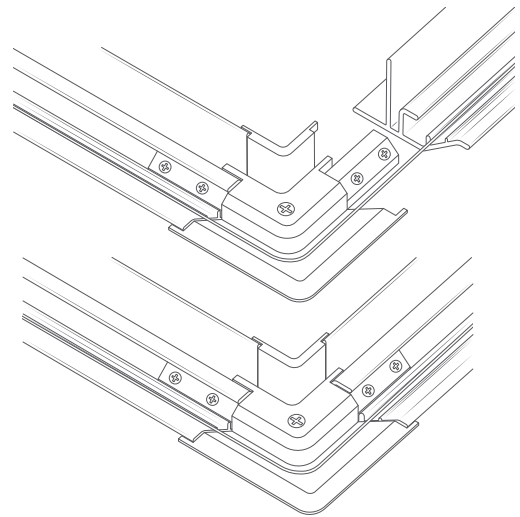

3 The Frame

Position the top part of the frame and place it onto the right and left side frame like before - slotting them into place, aligning, and fixing onto each side frame with the screws provided.

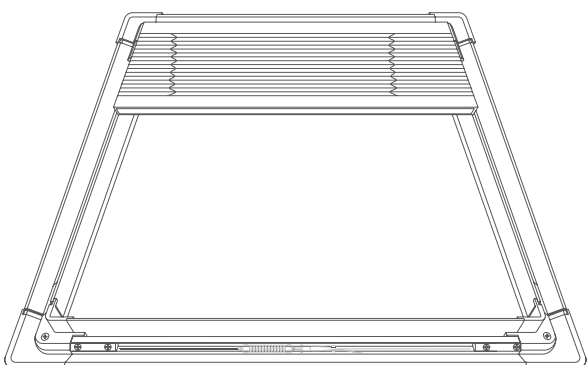

4 Tension Hook

Connect the hook and spring section together to apply appropriate tension to the blind within the frame.

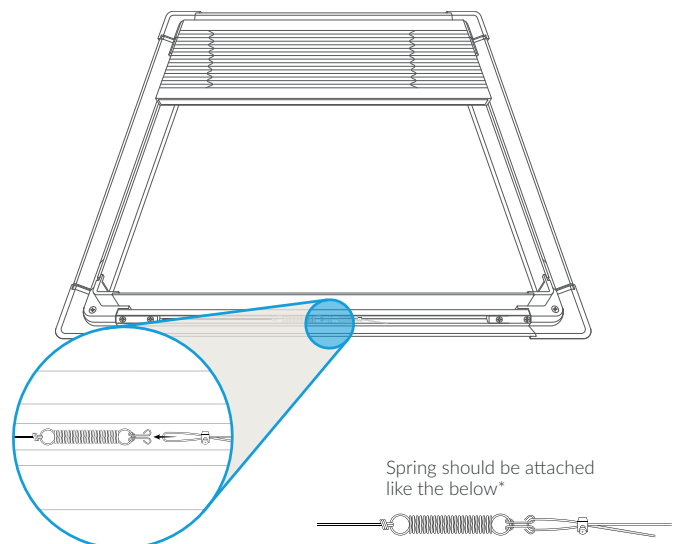

Spring should be attached like the below*



5 The Brackets

Measure 85mm distance from the corner of the frame up the side of the panel. You can do this simply by resting a credit card vertically on the frame. Line up the frame clip with the top of the credit card and then slot the clip into place, pushing the clip into the seal against the glass. Repeat this process for all four corners. For ease of insertion, you can use a lubricant, such as washing up liquid, on the base of each frame clip.

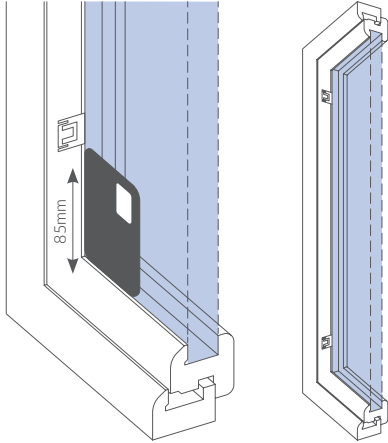

6 Fixing in Place

Once you have the four frame clips fixed into place, carefully slot the Perfect Fit blind onto the clips, pressing firmly until you hear a clicking sound.

