

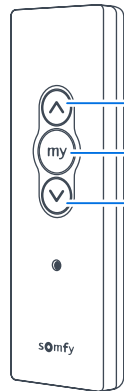

GET TO KNOW YOUR REMOTE

A remote can have one or more channels depending on your purchase. You can pair up to ten blinds per channel which will all be operated at the same time.

Note: Other Somfy controls and wall switches will operate the same way based on the control buttons.



SITUO RTS
Single Channel Control



SITUO 1 RTS
Single Channel Control



SITUO 5 RTS
Multi Channel Control



BEFORE YOU BEGIN PAIRING PROCESS AWAKE YOUR MOTOR

To activate the motor, use a pin or paperclip to briefly press the button next to the charging socket, or connect the charger. The blind will jog up and down three times indicating the motor is active.

If your blind doesn't jog, simply plug in the power adapter for 3-4 hours. **Note: the charging connector will only fit one way. See graphic for more information.**

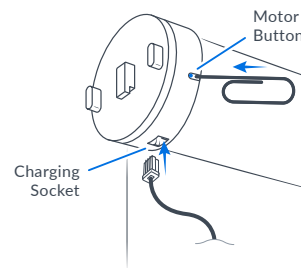

NOTE
If you are setting up multiple electric blinds, complete the setting up process of one blind before waking up any subsequent blinds.



1 Pairing A Blind To A Remote

Whether you're setting up a single channel remote, or a multi channel remote, the setting up process is exactly the same.

- 1 If you are using a multiple channel remote, set your remote to the channel you will connect this blind to.
- 2 To pair your remote to the blind, press the **UP** and **DOWN** BUTTONS on your remote together.

The blind will then briefly jog up and down indicating it is now paired with the remote.



2 Checking The Direction Of Travel

- 1 Check the direction of travel by pressing and holding the **DOWN** BUTTON until the blind moves. Release the button to stop it. If the blind moves downwards, it is correctly set up and you can progress directly to **step 3**.
- 2 However, if the blind starts to go up while pressing the down button, press and hold the **"MY"** button until it jogs, and press the **DOWN** BUTTON again to lower your blind and verify the direction is now set correctly.

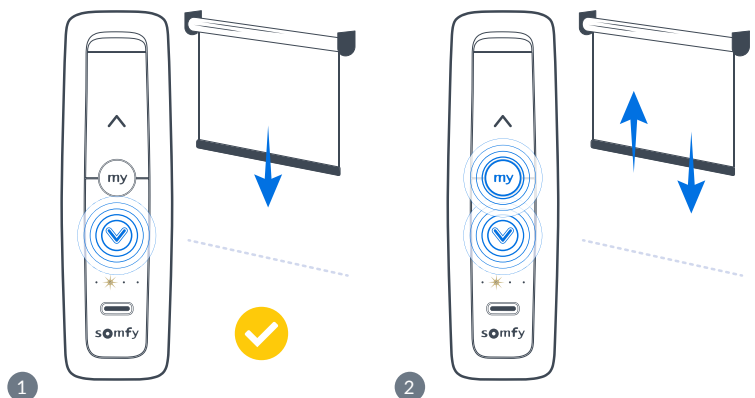

Setting Your Blind's Open & Closed Positions

- 1 To set the closed position for your blind, press and hold the **DOWN BUTTON** to move your blind and once at the desired location release the button. You can fine tune this by tapping the up and down buttons as required.
- 2 Once the blind is in your preferred closed position, press and hold both the **"MY" BUTTON** and the **UP BUTTON** simultaneously. When the blind begins to rise, the closed position has been set.
- 3 Press the **"MY" BUTTON** when your product reaches the desired open position. You can fine tune this position by tapping the up and down buttons as required.
- 4 Once the blind is in your preferred open position, press and hold both the **"MY" BUTTON** and the **DOWN BUTTON** simultaneously. When the blind begins to lower, the open position has been set. The blind will automatically stop at your preferred closed position.

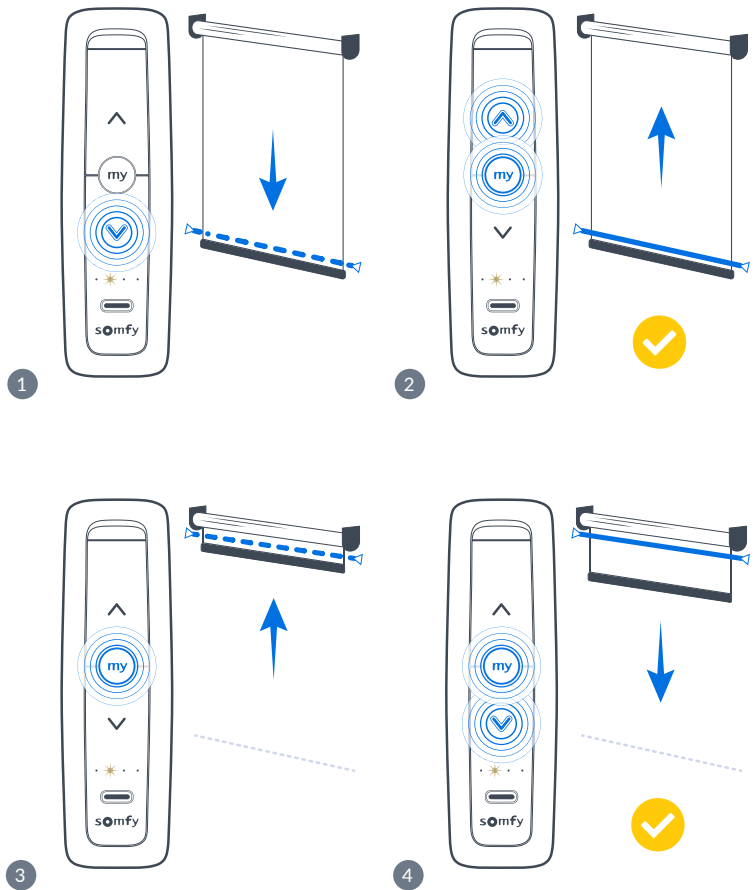

Completing The Pairing Process

- 1 Press and hold the **"MY" BUTTON** until the blind briefly jogs up and down.
- 2 Complete the process, using a pin or paperclip to tap (0.5s) the **"PROG" BUTTON** on the back of the remote once. The blind will jog up and down to confirm. The programming process is complete and the blind motor is programmed.

The blind will now operate with a brief press of the Up or Down buttons and automatically stop at the preset stop positions.

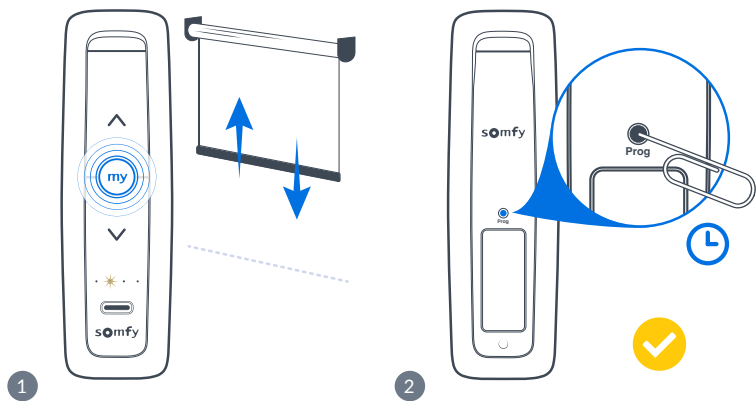

NOTE

You must have completed the previous steps including the confirmation of chosen positions before moving on to set up the next blind.

Before Setting Up Your Next Blind

Before moving to the next blind, put the previously set up blind/s into sleep mode.

- 1 First, press and hold the **MOTOR BUTTON** until the blind jogs once.
- 2 Press and hold all three buttons on the remote simultaneously until the blind jogs once.

Once all blinds are set up, wake each blind up by tapping the motor button on the blind until the blind jogs.

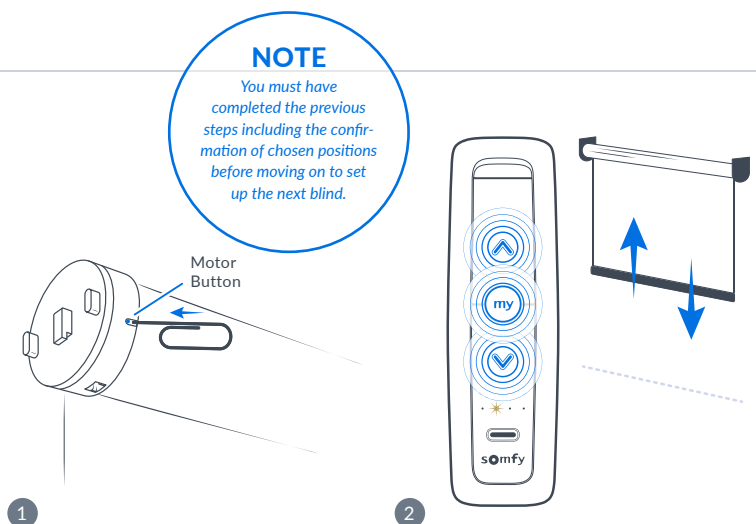



Recharging The Battery

Depending on the size of your blinds, the motor will need recharging typically every 6-12 months. Your motor contains a built-in rechargeable battery, and when the battery needs recharging, the blind will jog intermittently to draw attention. To charge the batteries, simply plug in the provided power adapter for 3-4 hours. It will jog and the LED on the plug will turn red. Once the LED turns green, the battery is fully charged.

Note: the charging connector will only fit one way. See graphic for more information.

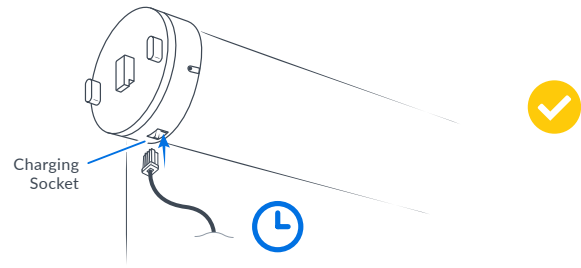

ADVANCED SETTINGS

Adding Multiple Blinds To A Control Channel On A Multichannel Remote

- To add multiple blinds to one channel so that they operate at the same time, follow these steps.
- Select the existing channel you'd like to copy then press and hold the "prog" button on the back of the remote until the blind jogs.
- Select the channel to become the "multi blind channel" and tap the "prog" button on the back of the remote until the appropriate blind jogs. This indicates the settings have been copied.
- Repeat as needed to add more blinds to your designated "multi blind channel".

Setting A Favourite Position

- Using the up and down buttons as required, find a position that you'd like to favourite and press the "MY" button to stop the blind.
- Press and hold the "MY" button until the blind briefly jogs up and down. The position is now set.
- Once set, simply press the "MY" button to move the blind to your favourite position.

Adjusting Upper & Lower Limits

- Once your blind is set up, if you need to edit your open or closed limits, first move your blind to the limit you want to adjust.
- Click and hold the up and down buttons simultaneously until the blind jogs up and down.
- Click and hold the up or down buttons to move the limit.
- Click and hold the "MY" button until the blind jogs to confirm the new limit.

Changing Speed

- To change the speed of your blind, first move the blind to a non-preset position.
- Press all three buttons on the front of the remote at the same time.
- The blind will begin moving up and down to demonstrate the speed options.
- Click and hold the up button, the blind will stop, jog and move to a quicker setting.
- Alternatively, hold the down button, the blind will stop, jog, and move to a slower setting.
- If the blind has reached the quickest or slowest setting, the blind will jog up and down three times and continue moving. Click and hold the "MY" button to confirm the new speed. The blind will jog to confirm.



Electric Blinds - Recycling Expired Batteries

We are committed to reducing waste. As part of this commitment we will accept returned batteries and arrange for the recycling of expired batteries from your electric blind.

To arrange collection:

- Call 01924 481729 - and let us know you are planning to return your battery.
- Remove the motor housing the battery from the blind and package securely, including your original order number on the packaging.
- Arrange delivery of your package via a courier of your choice.
- Upon receipt the battery will be recycled with appropriate waste management services.